

>>

System CRD14-System LLN8 / 10553534

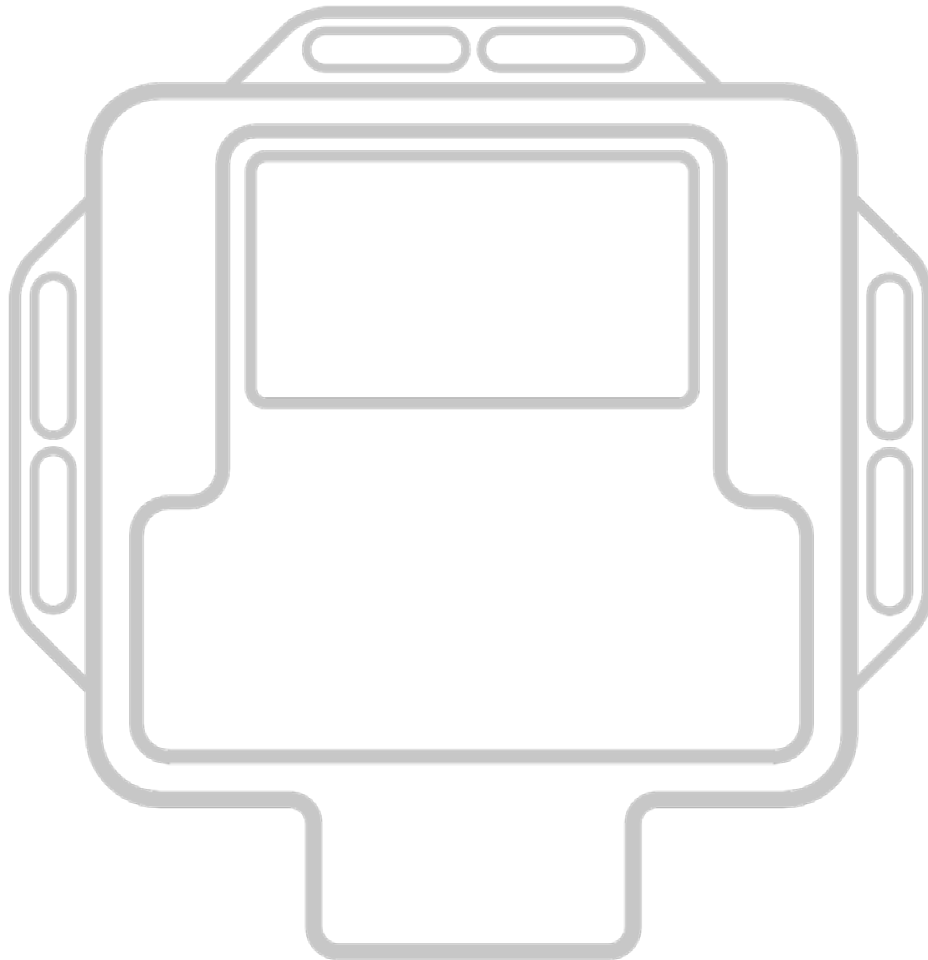

ENG30099

>>

Table of Contents

Scope of delivery / Preliminary	3
General instructions	4
Installation principle	5
Changing Programs	6
Trouble shooting	7
Installation example	8

>>

Scope of delivery

- Performance Pack
- Harness
- Dummy plug
- Fixing Set
- Sticker
- Installation Instructions

>>

Preliminary

The Performance Pack is specifically tuned and programmed for your vehicle. Due to production variations, the expected result of the Performance Pack can turn out differently (higher or lower). Also, the increased performance always depends on the maintenance condition and mileage of the vehicle.

If the power is too high, shown by a strong soot formation, disturbed engine run, engine misfire or the initiation of the engine emergency manifests itself: a program change is possible (see page 5). **IMPORTANT: When changing the program contact your dealer or manufacturer!**

>>

General instructions

Read this installation guide carefully before starting the installation so that you will be able to use all the technical advantages of the systems and do not start with the installation before you have read and understood the instructions.

If you comply with the advice given below (1) you will avoid an early termination of the product guarantee and you will be enjoying your product for years to come.

(2) Never install the system if the ignition is on. Pull the ignition key.

(3) After switching off the ignition, wait for 5 minutes until all electric devices are turned off.

(4) If possible, install the module in a dry area in the engine compartment. Humidity and wetness contain minerals which cause corrosion to the electronic circuits. Fix the harness and protect it from humidity.

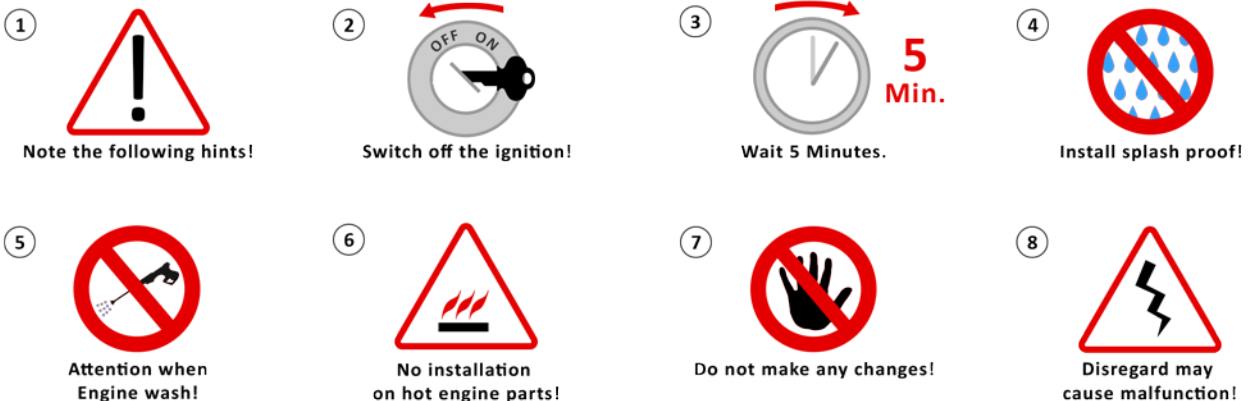

(5) Before every engine wash, remove the entire tuning system.

(6) Do not fix tuning systems to engine parts that could heat up. Never fix the module directly or close to the engine (engine block). High temperatures can reduce the lifespan of electronic devices and can deform or melt specific plastics materials.

(7) Take care that the harness does not touch the parts in motion and the metal parts to avoid friction. Do not make any changes to the harness (do not make it any longer or shorter).

(8) In case of the malfunctioning of the system due to any non-compliance with the instructions during the installation of the tuning modules, the product guarantee will be terminated.

>>

Installation

Localise the intake manifold pressure sensor (A), the boost pressure sensors (B) and the camshaft sensor (C). Open each of the connectors and connect the cable adapter with the sensors.

Advice! You can't find the sensors? The 4-pin intake manifold pressure sensor is located in the right top area directly at the intake manifold. The also 4-pin boost pressure sensor is located top right at the intake tube before throttle valve. The 3-pin camshaft sensor is located at the top left area from the engine. Note that you don't connect the adapter cable on other plugs. On the following pages you will find an illustrated guide.

Move the adapter cable not in parallel with injection pipelines or ABS-control device connecting leads. Keep to very big distances. Fix the cable harness with cable ties. Connect the module with the adapter cable. The module should be obstructed possibly against warmth and splash water protected.

>>

Installation principle

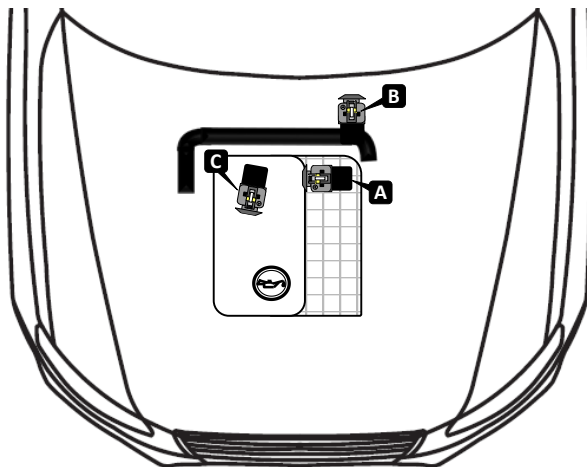

- A** Intake manifold pressure sensor (4 pin)
- B** Boost pressure sensor (4 pin)
- C** Camshaft sensor (3 pin)

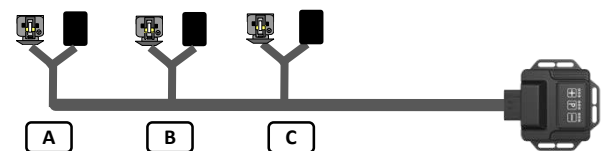

cable harness sticker:

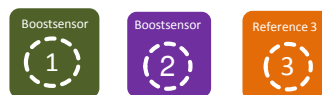

>>

Program Adjustments

You purchased a Chiptuning module for your vehicle. This module already includes a vehicle specific tuning. If you need to alter this setup, then follow the instructions below.

Remarks:

- The module is delivered with the best tuning possible for your vehicle, therefore it is not necessary to change the setup.
- Before you make any changes to the setup, you should always contact your dealer or manufacturer in advance.
- When the LEDs are flashing, the buttons of the keypad are locked.
- Each tuning setup can be increased or decreased by three stages using the + and – buttons.
- The LEDs on the module have an important role during the program change. They will indicate which tuning program you have selected with which fine adjustment.

Fig. A

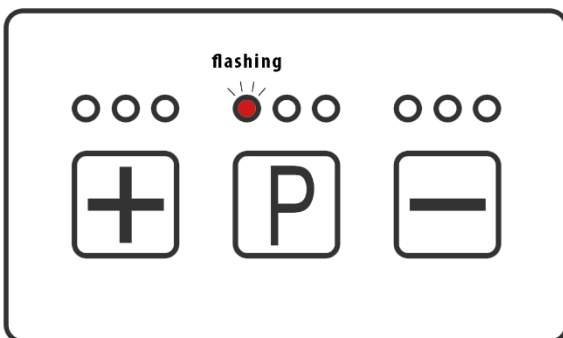

Step 1: Unlocking the Keypad

When the module is active, you will notice that the first LED above **P** (= Program) flashes red at position 1 (= Pos. 1). This indicates that tuning program 1 is selected (see Fig. A).

Before making a program change, press and hold the + and – buttons simultaneously for 5 seconds to unlock the keypad.

Fig. B

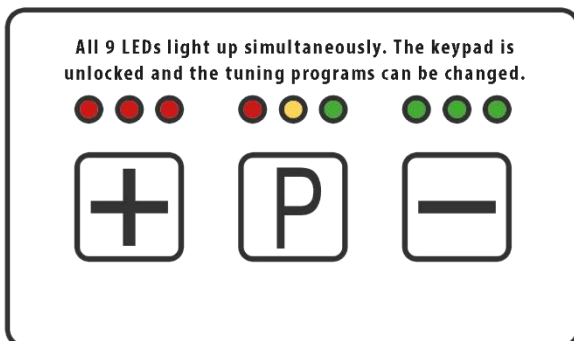

Important: Press and hold the + and – buttons until all 9 LEDs light up simultaneously (see Fig. B). Only then should you let go of the buttons and start changing the program.

Step 2: Changing the tuning program

The various tuning programs are represented by different color LEDs above the **P** button as shown in Fig. C.

Fig. C

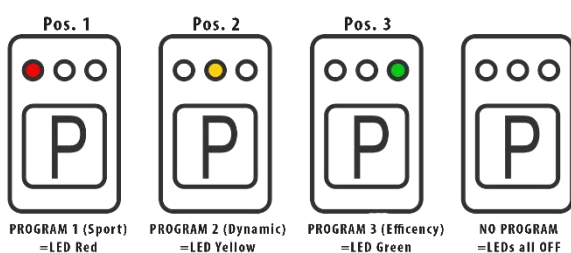

If you press the **P** button, after unlocking the keypad, you will see the LEDs switch from red (= Program 1 [Sports]) to yellow (= Program 2 [Dynamic]).

When pressed again the LEDs will switch from yellow to green (= Program 3 [Efficiency]).

Pressing the **P** button for a third time the LEDs will turn off. This indicates there is no tuning program selected. If you continue to press the **P** button you will go through the program selection in the same order.

>>

Program Adjustments

Fig. D

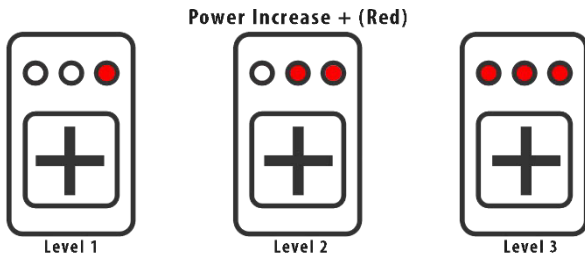

Fig. E

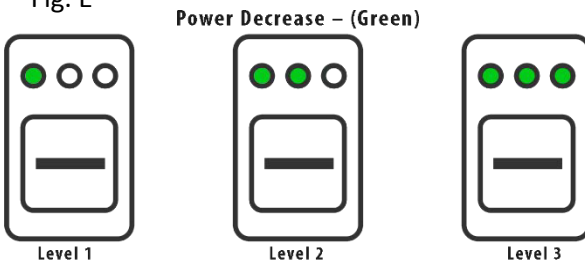

Fig. F

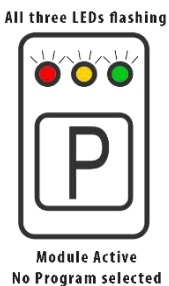

Fig. G

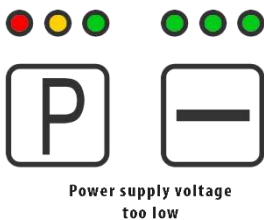
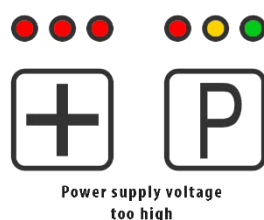

Fig. H



Step 3: Changing the fine adjustment

By changing the fine adjustment you can change power delivery of your vehicle. Each tuning program can be increased or decreased by 3 levels using the + and - buttons.

To increase the power delivery, after unlocking the keypad, press the + button. The first red LED (level 1) above the + button lights up.

Pressing the + button again will increase the power delivery again with one level and the second red LED (level 2) will light up. Pressing the + button for a final time will increase the power delivery to the maximum level (level 3). Now all three red LEDs will be light up. The levels are shown in Fig. D.

To decrease the power delivery, repeat the same process as with increasing the power delivery but this time use the - button. The different levels are shown in Fig. E.

Step 4: Saving the selected tuning program

If no buttons are pressed for a period of 10 seconds, the selected tuning program will be automatically saved and selected. The keypad buttons are also locked.

Note:

- If all three LEDs above the P button are flashing, this indicates that the module is active, however there is no tuning program selected and the keypad buttons are locked (see Fig. F).
- When the provided power supply voltage is considered too low, all LEDs above the - and P button will flash permanently (see Fig. G).
- Likewise when the provided power supply voltage is too high, all LEDs above the + and P button will flash permanently (see Fig. H).

Error descriptions*	Problem solution?
„The engine doesn't start.“	<ul style="list-style-type: none"> ▪ Check all connected components. Are the adapter plugs in the right position? ▪ Is a plug twisted connected? If possible? ▪ Do the LED's work properly (see chapter „Program Changing“)? <p><i>Error persists</i> > Replace module with enclosed blind plugs and start again.</p> <p><i>Error fixed?</i> Module is defective: Contact the vendor / manufacturer</p>
„The engine doesn't run smoothly. The engine is bucking.“	<ul style="list-style-type: none"> ▪ Check all connected components. Are the adapter plugs in the right position? ▪ Has the program been changed?(see chapter „Program Changing“)? ▪ <i>Error persists</i> > Contact the vendor / manufacturer
„The fail-save program runs immediately. The Malfunction Indication Light (MIL) flashes in the Instrument Cluster.“	<ul style="list-style-type: none"> ▪ Check all connected components. Are the adapter plugs in the right position? ▪ Reduce the Performance Pack by one or two levels (see chapter „Program Changing“). ▪ <i>Error persists</i> > Contact the vendor / manufacturer
„The fail-save runs in higher RPM.“	<ul style="list-style-type: none"> ▪ Check all connected components. Are the adapter plugs in the right position? ▪ Reduce the Performance Pack by one or two levels (see chapter „Program Changing“). ▪ <i>Error persists</i> > Contact the vendor / manufacturer
„The engine shows no extra performance.“	<ul style="list-style-type: none"> ▪ To obtain the maximum benefit, use a higher-octane fueled (98 ROZ or higher) ▪ Reduce the Performance Pack by one or two levels (see chapter „Program Changing“). ▪ <i>Error persists</i> > Contact the vendor / manufacturer
„The engine produces too much soot.“	<ul style="list-style-type: none"> ▪ Check all connected components. Are the adapter plugs in the right position? ▪ Reduce the Performance Pack by one or two levels (see chapter „Program Changing“). ▪ <i>Error persists</i> > Contact the vendor / manufacturer
„How can I get back to the original performance of the engine?“	<ul style="list-style-type: none"> ▪ Press and hold the buttons (+) and (-) for three seconds. Your vehicle is now in production configuration. <p><i>or</i></p> <ul style="list-style-type: none"> ▪ Follow the steps below: <ol style="list-style-type: none"> 1. Turn off the ignition. 2. Wait until all electrical consumers are off. 3. Remove the Performance Pack of all connected components or use included dummy plug.

* The fault description applies to both diesel and gasoline engines.

>>

Installation example



Open the engine hood. Remove the engine cover.



Connect the System to these 3 sensors:

- Intake manifold pressure sensor
- Boost pressure sensor
- Camshaft sensor

The 4-pin intake manifold pressure sensor is located in the right top area directly at the intake manifold. The also 4-pin boost pressure sensor is located top right at the intake tube before throttle valve. The 3-pin camshaft sensor is located at the top left area from the engine.

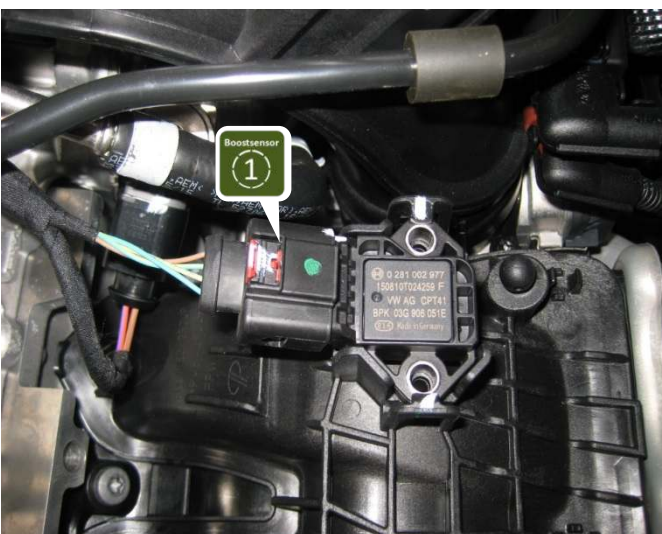

Localise the 4 pin intake manifold pressure sensor.

>>

Installation example



Open the plug by pressing the locking lever and connect the adapter in between both connections.

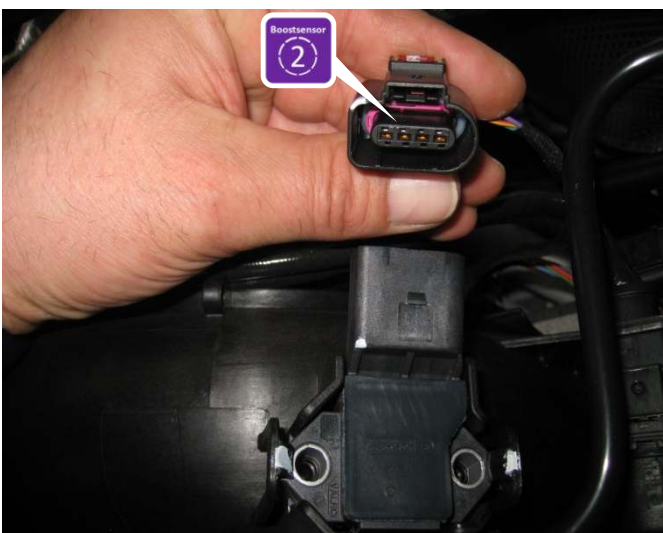

Localise the top right area of the engine compartment. The boost pressure sensor is located top right at the intake tube before throttle valve. Open the plug by pressing the locking lever and connect the boost pressure adapter in between both connections.



The 3-pin camshaft sensor is located at the top left corner from the engine.

>>

Installation example

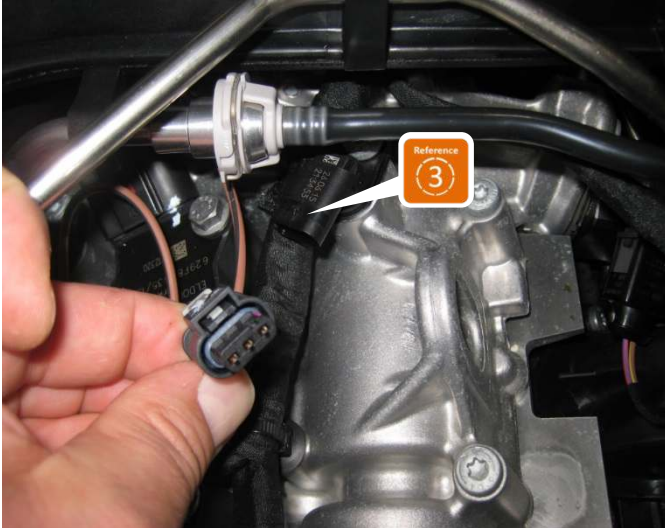

Open the plug by pulling the locking lever. Connect the camshaft sensor adapter in between both connections.

Incorrect installation may cause damages to the engine control unit and/or sensors!



Move the adapter cable not in parallel with injection pipelines or ABS-control device connecting leads. Keep to very big distances. Fix the adapter cable with cable ties. Connect the module with the adapter cable.

Check all connections again and reassemble the vehicle in reverse order.