

PowerControl

Installation instructions

9074



ENG80068

>>

Table of Contents

Scope of delivery / Preliminary
General instructions
Installation principle
Changing Programs
Trouble shooting
Installation example

>>

Scope of delivery

- Tuning module
- Harness
- Dummy plug (optional)
- Fixing set
- Installation instructions

>>

Preliminary

This tuning system is specifically customized and programmed for your vehicle. Due to production variations of engines in general, the expected result of the tuning system can turn out differently (higher or lower). Also, the increased performance always depends on the maintenance condition and mileage of the vehicle.

If the power is too high, shown by a strong soot formation, disturbed engine run, engine misfire or the initiation of the engine emergency, you can fine-adjust the system. (see chapter "Programs").

IMPORTANT: When changing the program in this case, contact your dealer or the manufacturer!

>>

General instructions

Read this installation guide carefully before starting the installation so that you will be able to use all the technical advantages of the systems and do not start with the installation before you have read and understood the instructions.

If you comply with the advice given below (1) you will avoid an early termination of the product guarantee and you will be enjoying your product for years to come.

(2) Never install the system if the ignition is on. Pull the ignition key.

(3) After switching off the ignition, wait for 5 minutes until all electric devices are turned off.

(4) If possible, install the module in a dry area in the engine compartment. Humidity and wetness contain minerals which cause corrosion to the electronic circuits. Fix the harness and protect it from humidity.

①



Note the following hints!

②



Switch off the ignition!

③



Wait 5 Minutes.

④



Install splash proof!

⑤



Attention when
Engine wash!

⑥



No installation
on hot engine parts!

⑦



Do not make any changes!

⑧



Disregard may
cause malfunction!

(5) Before every engine wash, remove the entire tuning system.

(6) Do not fix tuning systems to engine parts that could heat up. Never fix the module directly or close to the engine (engine block). High temperatures can reduce the lifespan of electronic devices and can deform or melt specific plastics materials.

(7) Take care that the harness does not touch the parts in motion and the metal parts to avoid friction. Do not make any changes to the harness (do not make it any longer or shorter).

(8) In case of the malfunctioning of the system due to any non-compliance with the instructions during the installation of the tuning modules, the product guarantee will be terminated.

>>

Installation

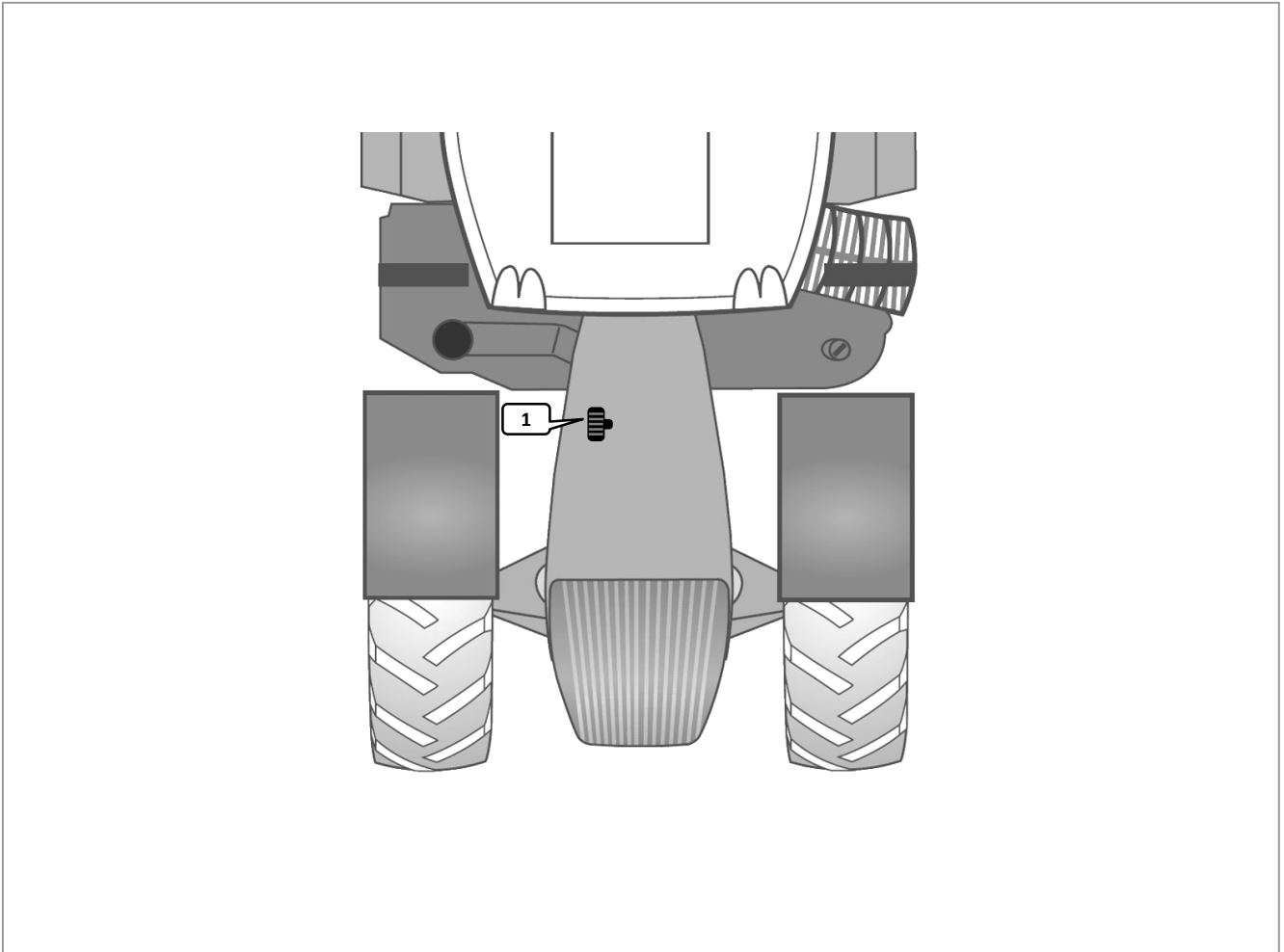

1 Compact Connection (10 pin)

+ **-** Power Supply

Harness
Sticker

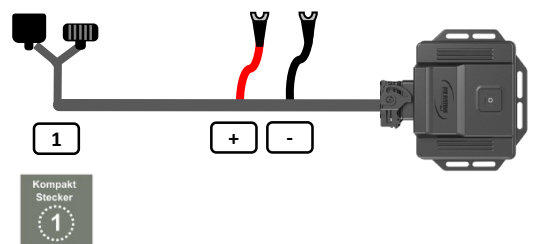

>>

Programs

You purchased a modern engine tuning system for your vehicle that features DTE Systems' multi-map technology, specially designed for your vehicle and engine type. In the factory setting the device already has been set-up specifically for your vehicle and engine type and is ready to use. Your tuning system includes 3 specific programs Sport, Dynamic and Efficiency that can be selected depending on your personal driving situation and optimization requirement.

Remarks

- The system's factory setting is adjusted to fit your personal vehicle, a further adjustment is not required.
- The LED signals an active tuning system and shows the selected program.
- In case of a blinking LED, the keypad lock is active.

Setting an alternative program

Deactivate the keypad lock by pressing and holding the **Program button**  for a minimum of 2 seconds.

Important: The keypad lock is active as soon the LED is permanently lit and not flashing.

By pressing on **Program button**  you can switch in between the activated **programs**. The colored circle shows the active program:



Sport (Factory setting) – The Sport program provides full performance in every driving situation



Dynamic – The Dynamic program offers a balanced power performance ideal for moderate driving situation without extreme load requirements



Efficiency – The Efficiency program optimizes the efficiency of the engine for a fuel-saving driving pattern



Stock – Your vehicle will be set into stock without any engine (White circle when the key lock is deactivated or flashing circle when the key lock is activated)

All settings are automatically saved after 60 seconds and the keypad lock will be re-activated.



Connecting smartphone app

Your tuning system features a modern Smart Phone-Connect- Interface that allows to control the central functions of your tuning system via your Smart Phone. To pair your PowerControl device with your Smart Phone, please follow the steps below.

Apple iPhone

- Download the „PowerControl“ app by DTE Systems for free at the Apple App store on your iPhone.
- Turn on ignition to start your PowerControl module. You will see a blinking LED.
- Deactivate the keypad lock by pressing and holding the **Program button**  for a minimum of 2 seconds. Your module now is in pairing mode.
- Open the PowerControl app and follow the instructions inside. Your smartphone will now connect to your PowerControl system. In case you are asked for a **PIN code**, please enter **000000** .

Android

- Download the „PowerControl“ app by DTE Systems for free at the Google Play store.
- Turn on ignition to start your PowerControl module. You will see a blinking LED.
- Deactivate the keypad lock by pressing and holding the **Program button**  for a minimum of 2 seconds. Your module now is in pairing mode.
- Open Bluetooth settings inside the Android's settings menu.
- The PowerControl module is visible in pairing mode with the name DTE-xxxxxxx. **Pair the DTE device.** In case you are asked for a **PIN code**, please enter **000000** . For questions to pair a Bluetooth device with your Android phone, please consult your Smart Phone manufacturer.

Positioning: The Connect module with the Bluetooth unit should be positioned as close as possible to the driver to ensure the best possible connection.

Compatibility: The PowerControl App is compatible with all Apple iPhones (later than 4S) with iOS 10 or later as well as most Smart Phones with Google Android 7.0 or higher with Bluetooth LE. Please check the website for specific compatibility for your Smart Phone. We recommend to use the latest operating system version to prevent limited compatibility with Bluetooth LE standards. For further information please read instructions inside the app or in the app stores carefully. Features might vary depending on your Smart Phone's and vehicle's capabilities.

Your tuning system is equipped with one of the strongest certified Bluetooth LE radio modules to achieve the best possible connection quality. Keep distance as low as possible and prevent massive metallic components like main engine block or turbos to be located between module and the car's interior to improve reception. Strong Bluetooth radio emitter in your surrounding might temporarily affect the radio connection and remote functions of the app, however, they will not compromise the functionality of your tuning system.

Legal notice: Usage of smartphones while driving is not allowed in many countries. Please comply to national legislation applicable to you. For usage we recommend to have a fixed smartphone mount in which the phone is placed before driving and instruments are preset.

Installation instructions

| Error descriptions* | Problem solution |
|---|--|
| „The engine doesn't start.“ | <ul style="list-style-type: none"> ▪ Check all connected components. Are the adapter plugs in the right position? ▪ Is a plug twisted connected? If possible? ▪ Do the LED work properly (see chapter „Program Changing“)? <p><i>Error persists</i> > Replace module with optionally enclosed blind plug or disconnect the module from the wiring harness and start again.</p> <p><i>Error fixed?</i> Module is defective: Contact the vendor / manufacturer</p> |
| „The engine doesn't run smoothly. The engine is bucking.“ | <ul style="list-style-type: none"> ▪ Check all connected components. Are the adapter plugs in the right position? ▪ Change program to Dynamic (see chapter “Program”) ▪ <i>Error persists</i> > Contact the vendor / manufacturer |
| „The fail-save program runs immediately. The Malfunction Indication Light (MIL) flashes in the Instrument Cluster.“ | <ul style="list-style-type: none"> ▪ Check all connected components. Are the adapter plugs in the right position? ▪ Change program to Dynamic (see chapter “Program”) ▪ <i>Error persists</i> > Contact the vendor / manufacturer |
| „The fail-save runs in higher RPM.“ | <ul style="list-style-type: none"> ▪ Check all connected components. Are the adapter plugs in the right position? ▪ Change program to Dynamic (see chapter “Program”) ▪ <i>Error persists</i> > Contact the vendor / manufacturer |
| „The engine shows no extra performance.“ | <ul style="list-style-type: none"> ▪ Contact the vendor / manufacturer |
| „The engine produces too much soot.“ | <ul style="list-style-type: none"> ▪ Check all connected components. Are the adapter plugs in the right position? ▪ Change program to Dynamic (see chapter “Program”) ▪ <i>Error persists</i> > Contact the vendor / manufacturer |
| „How can I get back to the original performance of the engine?“ | <ul style="list-style-type: none"> ▪ Change program to stock (see chapter “Program”) <p><i>or</i></p> <ul style="list-style-type: none"> ▪ Follow the steps below: <ol style="list-style-type: none"> 1. Turn off the ignition. 2. Wait until all electrical consumers are off. 3. Remove the tuning module of all connected components <p>or use the optionally included dummy plug.</p> |
| | |

>>

Installation example

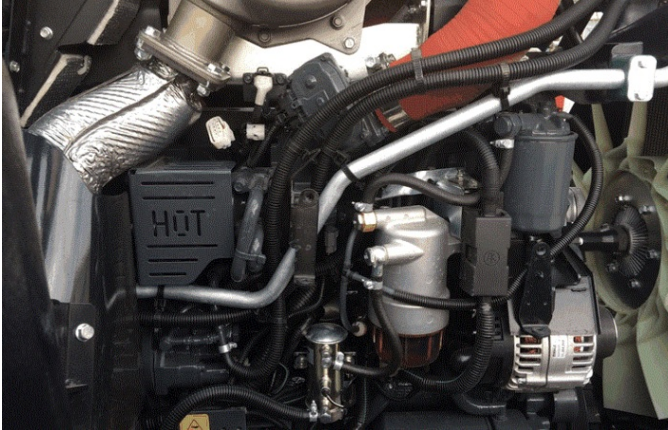

Open the engine hood.

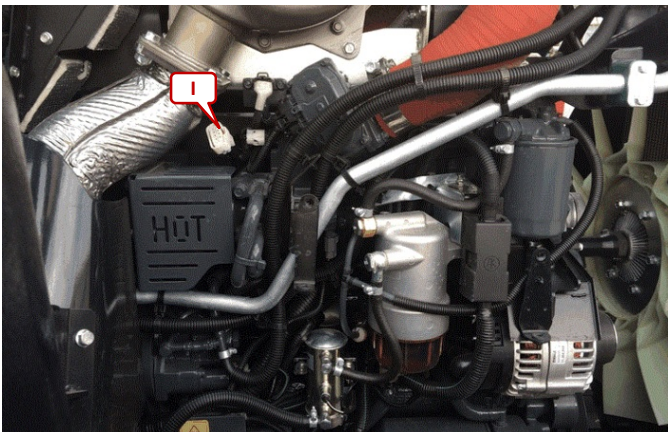

Localise the right side of the engine see in driving direction. Localise the 10-pin injector plug (I). Open the injector plug. Connect the adapter cable in between these connection.



Connect the power supply to the vehicle battery. You can alternatively connect the + 12 V clamp to the positive pole from the generator. Connect the ground clamp to the ground from the vehicle body. Fix the cable harness with cable ties. Connect the module to the adapter cable. Check all connections again and re-assemble the vehicle in reverse order.